

Cone Beam 3D Imaging  
**NewTom**  
what's next



Making Your Life Better.

**BU Medical Equipment**

Sede legale ed amministrativa  
Headquarters

CEFLA s.c.  
Via Selice Provinciale 23/a ▪ 40026 Imola ▪ Italy  
t. +39 045 8202727 ▪ 045 583500  
info@newtom.it

**Stabilimento  
Plant**

Via Bicocca, 14/c  
40026 Imola ▪ Bo (Italy)  
tel. +39 0542 653441  
fax +39 0542 653601

newtom.it



09/2021 NHRGB181S01  
According to the standards in force, in extra-EU areas the availability and specifications of some products and/or characteristics may vary. Please contact your local distributor for further information. Pictures are for illustration purpose only.

# NewTom GIANO HR PERFECT.VISION

UNLIMITED DIAGNOSTIC POTENTIAL



**DC III**  
Cone Beam 3D Imaging  
**NewTom**  
what's next



## GiANO HR PERFECT.VISION

---

THE COMPLETE  
HYBRID CBCT FOR  
2D/3D IMAGING.  
HIGH RESOLUTION  
IMAGES THAT  
CAPTURE THE  
SMALLEST DETAIL.  
FROM TODAY  
ALSO WITH DIRECT  
CONVERSION.

GiANO HR is NewTom's versatile and updatable device for all radiology-related needs. With a complete range of 2D and 3D examination options for dentistry, it offers specific multiple volumetric examinations for maxillofacial surgery, otorhinolaryngology and cervical spine examinations. Only top quality imaging with NewTom's technology and experience.



## PERFECT VISION.

NewTom innovation and research for extremely detailed ultra-high quality images.

Innovative technology and outstanding efficiency packed into a powerful, versatile device. GiANO HR ensures superb performance in every situation thanks to the dedicated 2D sensor, available today also as a direct conversion, relocatable sensor, the new-concept teleradiographic system and three easy-to-upgrade 3D configurations that meet every need.

The powerful NNT software provides specific instruments and interfaces for different diagnostic applications: data acquired during scanning can be processed in just a few simple steps to produce 3D images with a resolution among the highest available on the market.

Low-dose protocols, SafeBeam™ technology and servo-assisted alignment always ensure low radiation doses for patient protection. A choice of three different emission levels lets users adjust patient exposure by taking into account the actual diagnostic needs, while the new 10" touch screen control panel makes workflow even more versatile and user-friendly.

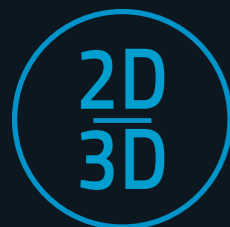

### POWERFUL DIAGNOSIS

Precise, perfectly defined FOVs ranging from 4 x 4 to 16 x 18 cm. Advanced ApT technology and teleradiographic function for high contrast, finely detailed images.



### NEWTOM HR - DC<sup>III</sup> TECHNOLOGY

Ongoing research and innovation have produced this device made up of innovative hardware technology and exclusive reconstruction algorithms.



### PATIENT SAFETY

Low-dose protocols, SafeBeam™ technology and servo-assisted alignment to protect patient health.



### 10" TOUCH CONSOLE

NNT, the powerful imaging software with specialist interfaces and tools, user-friendly workflow and online assistance.





# UNPARALLELED IMAGING.

Amazing 3D FOV examinations and 2D protocols with a resolution among the highest available on the market.

GiANO HR provides a wide range of 2D and 3D examinations that are ideal for diagnoses concerning either complete or partial dentition, single dental arches and all maxillofacial regions. 3D volumes with FOV from 4 x 4 cm and 16 x 18 cm and resolution up to 68  $\mu\text{m}$ , the highest available on the market, allow to assess maxillary sinuses, frontal sinuses, temporomandibular joints, airways, the internal ear and the cervical spine.

Top quality panoramic images enhanced by ApT technology, intelligent auto-adaptive filters and MultiPAN function. Ever clear and detailed teleradiographic images with the latest relocatable PAN/CEPH sensor, and with the possibility of installing the 2D direct conversion sensor for Ultra HD and ultra-low dose PAN/CEPH.

Superior quality imaging with dedicated protocols for the various applications, such as FOV 7 x 6 cm, which is ideal to examine the internal ear, or FOV 9 x 16 cm and 9 x 9 cm, specially studied for cervical spine examinations.



ApT technology provides consistently outstanding image quality with fully automatic acquisition of optimised, clear, homogeneous PAN images. And if you want the best, don't miss out on the new revolutionary sensor with DC<sup>III</sup> retrofittable technology.

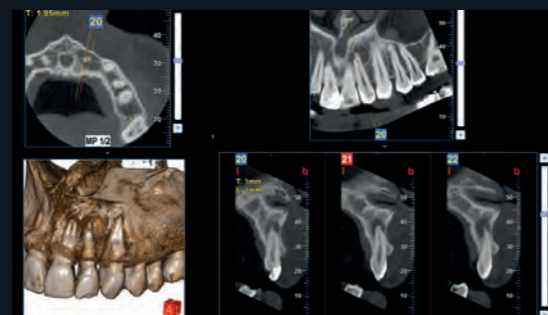

The exclusive XF (eXtra Functions) mode uses innovative acquisition protocols to achieve the exceptional resolution of 68  $\mu\text{m}$ , which is among the highest available on the market. The ideal solution to highlight every detail, especially for endodontic applications and internal ear examinations. Also available with FOV 9 x 9 for cervical spine examinations.



1

### 3D PRIME - 10 X 8

Highly suited to all dental diagnosis and implant-related needs.

2

### 3D ADVANCED - 13 X 16

Broader vision: from maximum endodontic resolution to complete otorhinolaryngology examinations.

3

### 3D PROFESSIONAL - 16 X 18

Full Head&Neck diagnostic performance to investigate the entire dental-maxillofacial district and cervical spine.



## REDEFINED 2D IMAGING.

The last word in terms of 2D technology for a wide range of diagnostic applications, also with Direct Conversion Detector.

GiANO HR is an extremely versatile device that offers detailed images and dedicated protocols for adults and children, studied to reduce patient exposure based on the actual needs of the investigation. Precise assessment of unerupted teeth, including fractures and bone irregularities, dental prostheses, braces and implants. A single device designed to offer new 2D technology for several diagnostic applications: complete panoramic images both for adults and children with excellent orthogonality, high resolution images of bitewing and of dentition (either complete or in quadrants), views of front and maxillary sinuses, and views of temporomandibular joints (TMJ) with open and closed mouth scanning options in a single sequence. With the easily relocatable CMOS Csl sensor and the latest generation teleradiographic system, and most importantly, the Direct Conversion Detector (DC<sup>III</sup>) option, GiANO HR produces high quality 2D images in all conditions for cephalometric and carpal examinations.



### ApT (AUTOADAPTIVE PICTURE TREATMENTS)

Auto-adaptive filters automatically improve every 2D image to ensure the best result for every projection.

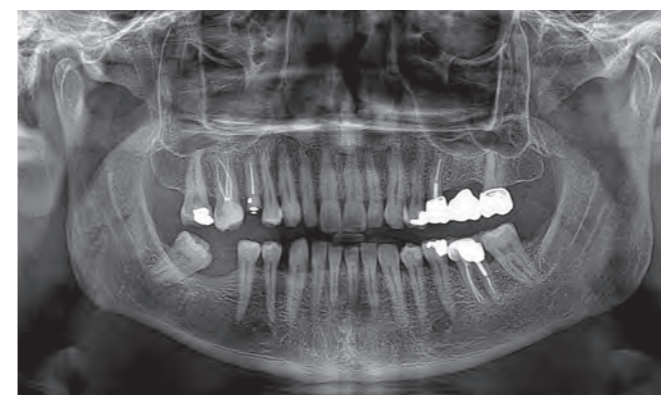

PANORAMIC IMAGING WITH EXCELLENT ORTHOGONALITY AND CONSTANT MAGNIFICATION



CHILD PANORAMIC WITH LIMITED EXPOSURE

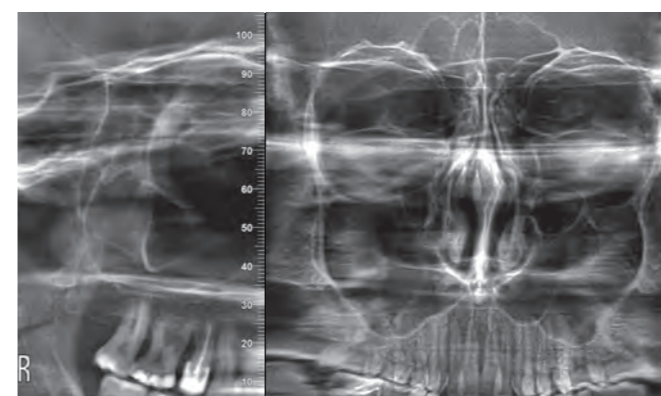

MAXILLARY SINUSES WITH FRONT AND LATERAL PROJECTIONS

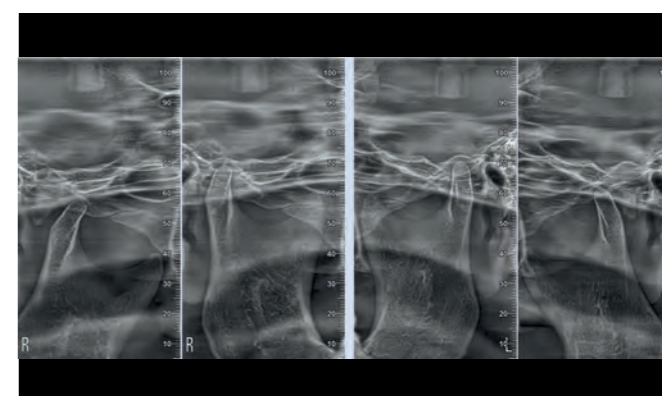

LL OR PA TMJ WITH OPEN OR CLOSED MOUTH

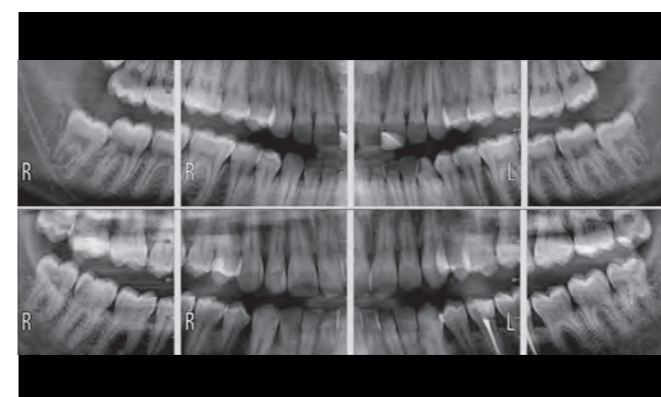

BITEWING HIRES

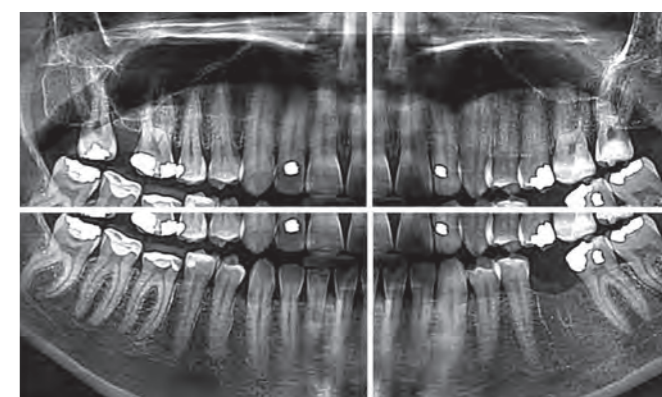

COMPLETE DENTITION OR IN QUADRANTS



FULL-LL, AP TELERADIOGRAPHY (ADULT AND CHILD)



CARPAL TELERADIOGRAPHY



## ULTRA HD 2D DIAGNOSTICS WITH ECO DOSE.

With the Direct Conversion Detector, GiANO HR brings the most advanced technology to each dental clinic.

The direct conversion sensor can raise the bar of the already very high imaging quality of GiANO HR even further. Unlike traditional sensors, the Cadmium Telloride (Cd-Te) Direct Conversion Detector does not require the conversion of X-rays into visible light - as it is capable of sensing it directly and converting it into precise, accurate digital signals. In this way, extremely high resolution diagnostic images can be obtained at low X-rays doses, and highly detailed images can be produced even where quick scans in ECO Dose are more indicated.

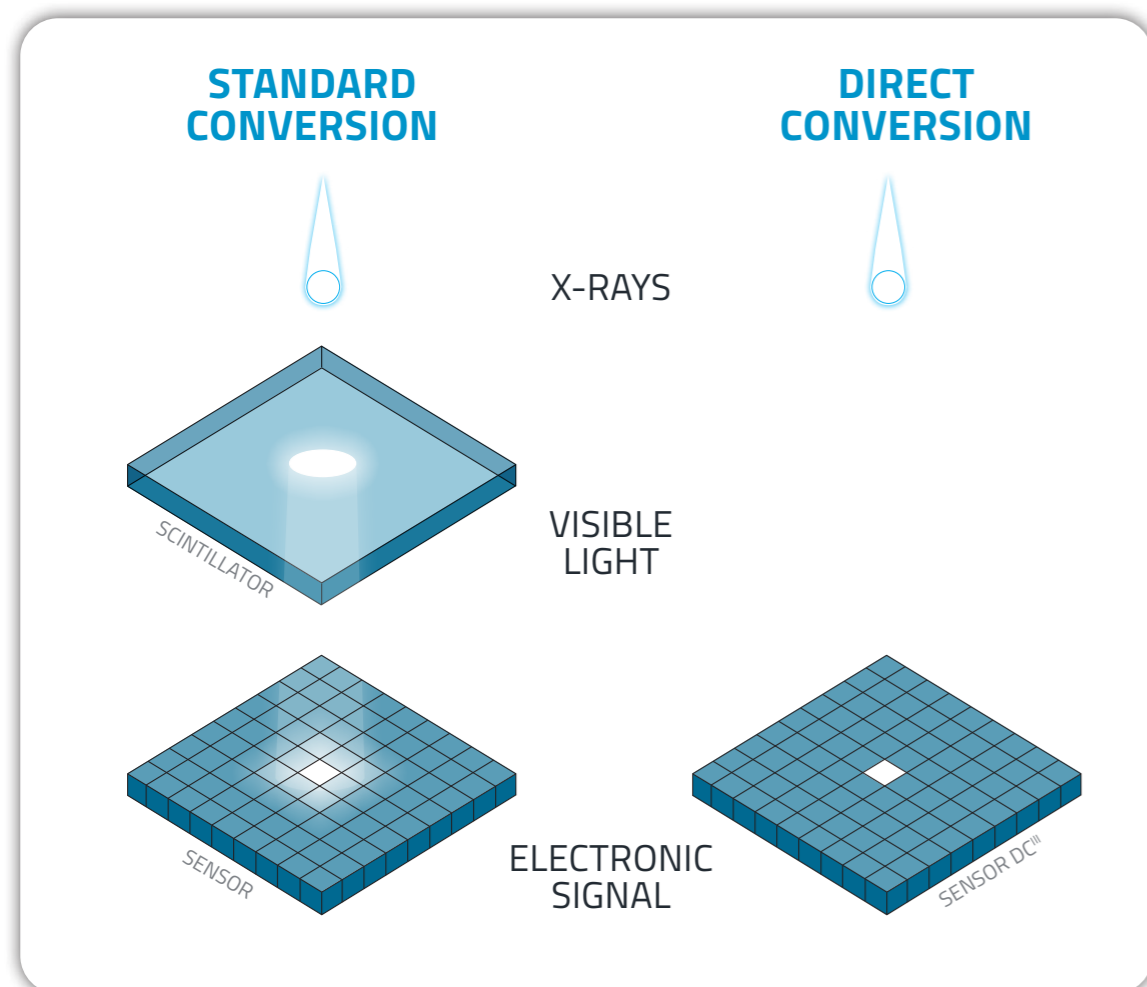

### DC™ 11 LAYER ULTRA HD PAN

The highly efficient Direct Conversion Detector, improving the depth of focus and increasing resolution even at low doses, offers an extended data set from which an 11-layer panoramic image can be obtained for the study of complex morphologies. The contrast level of the radiographic image obtained with the new NewTom DC™ technology improves significantly if compared to a panoramic scan performed with a traditional sensor with scintillator (CsI). In particular, the contrast level of a DC PAN increases by about 90%, practically doubling the resolving power @3 lpmm from 23% (CsI) to 43% (Cd-Te).

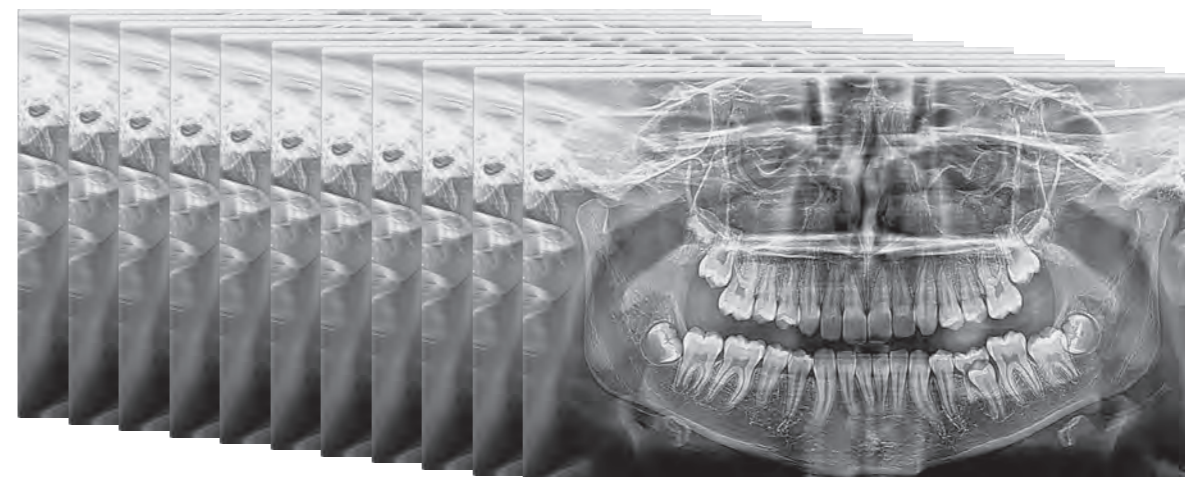

### DC™ ULTRA HD AND ECO CEPH

Thanks to direct conversion technology, Ultra HD latero-lateral cephalometric exams can be performed quickly with superior detail and sharpness at low doses. Moreover, in the case of surgical follow-ups or pediatric examinations, it is possible to use the ECO option for ultra-fast scans, including Postero-Anterior views, at high resolution and extra low dose.

The high sensitivity of the DC sensor allows for an almost tripled contrast level at a given resolution, using the same dose. For a Ultra HD CEPH captured with NewTom DC™ direct conversion technology, the resolving power @ 2.5 lpmm is 82% compared to 32% of a HD CEPH exam performed with a standard sensor with conventional scintillator (CsI).

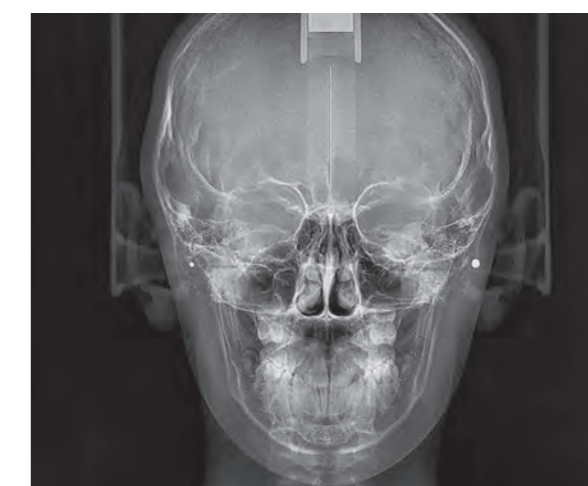

## 2D TECHNOLOGY, PERFORMANCE AND PRECISION.

Very high sensitivity 2D PAN-CEPH sensor (now also with DC<sup>III</sup> technology) and latest generation X-ray tube for clear and detailed examinations.

A cutting edge acquisition system to obtain clear and homogeneous panoramic and cephalometric images in an extremely compact device. The latest generation X-ray tube, combined with the advanced high-sensitivity CMOS sensors, offers cutting-edge, unique performance for the best image quality. GiANO HR is a fully upgradeable platform available both in standard configuration - with high definition sensor equipped with scintillator (Csl) - and with NewTom DC<sup>III</sup> technology, the direct conversion technology created by NewTom which, thanks to a quick coupling and release system of the sensor, can be retrofitted at any time, ensuring extremely high efficiency in all circumstances.

### RELOCATABLE 2D SENSOR

Sensor relocation from PAN to CEPH is fast, safe and highly versatile for faster diagnoses.



## 2D IMAGING

### COMPLETE CEPHALOMETRIC IMAGING

The high power X-ray tube and the renewed positioning system are designed to yield detailed teleradiographic images. The high sensitivity sensor, and even more effectively, the Direct Conversion Detector, ensures ultra rapid scans to enhance patient safety and comfort. The second collimator on the rotating arch makes patient access easier. The use of ear guards specially designed for paediatric applications allows the skull cap to be included in the scan, while reducing sub-chin tissue exposure.



### MULTIPLE PANORAMIC IMAGING (ApT)

The MultiPAN mode generates in a single scan a set of orthopantomographic images with different focussing. This function is essential for the study of complex morphologies. The number of X-ray images, from which to select the optimal one for specific diagnostic requirements, can vary from 5 (PAN HD with STANDARD sensor) to 11 (PAN Ultra HD with DC<sup>III</sup> sensor). Autoadaptive panoramic imaging with ApT (Autoadaptive picture Treatments) technology provides automatic optimal focus of front roots, adapting to the patient and improving quality in all anatomical areas in a dedicated manner.



### ADVANCED KINEMATIC FEATURES

Specially synchronised kinematics made up of one rotary movement combined with two simultaneous translatory movements ensures constant magnification in all projections, excellent orthogonality and exceptional quality diagnostic images.

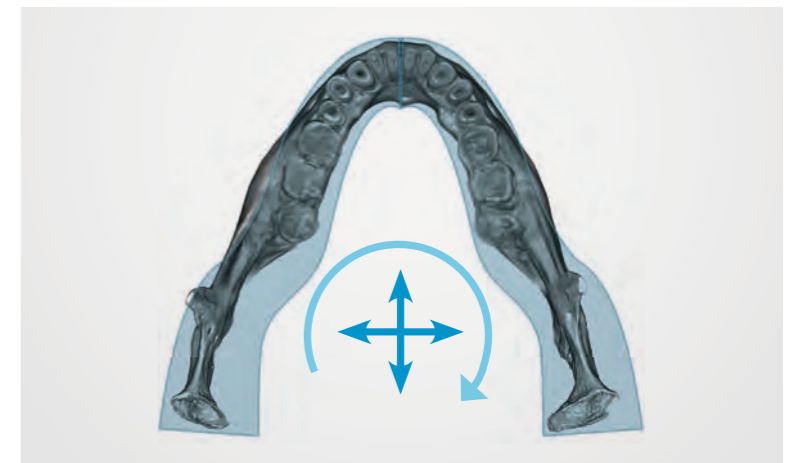



# 3D APPLICATIONS FOR EVERY DIAGNOSTIC NEED.

A broad range of FOVs for the best high resolution images available on the market.

GIANO HR generates volumes with a FOV range from 4 x 4 cm to 16 x 18 cm: accurate examinations for every diagnostic need.

Wide choice of fields of view and execution modes for dedicated applications for endodontic, otorhinolaryngology and Head&Neck examinations, with resolution up to 68 µm, which is among the the highest available on the market.



## TOUCH-SCREEN CONTROL PANEL

User-friendly features with excellent workflow efficiency. The user-friendly interface of the wide 10" on-board touch screen control panel enhances functional efficiency and makes the most of GiANO HR features.

## 3D IMAGING

### FOV 16 X 18 cm

Diagnosis of the entire dental-maxillofacial region to precisely plan orthognathic surgery for complete aesthetic and functional rehabilitation.

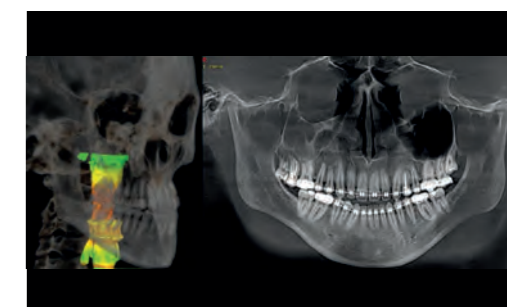
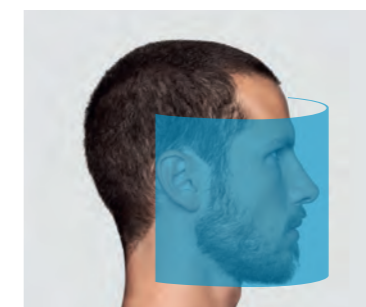

### FOV 15 X 6 cm

Detailed diagnosis of both the internal ear and petrous bones in a single Hi-Res scan.

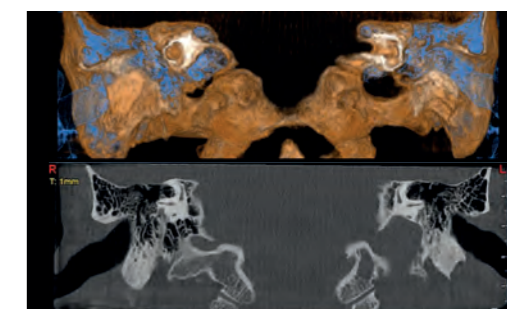

### FOV 9 X 16 cm

Complete high resolution volumetric examination of dysplastic, inflammatory and traumatic diseases of the cervical spine. Also possible with very high definition eXtra FOV 9 x 9 (68 µm voxel) for a localized study.

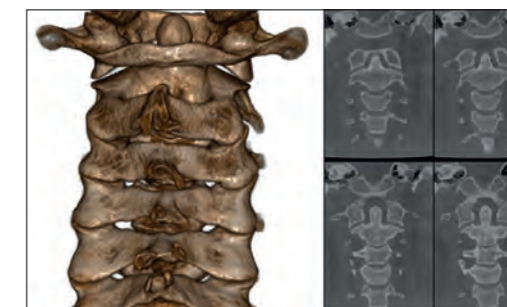

### FOV 4 X 4 cm

Ultra-high resolution examination (68 µm) of a specific region for an uncompromising endodontic examination with exposure limited to the region of interest. Or for simple follow-up morphological examinations with an ultra rapid (3.6 s) very low dose scan and real time view.

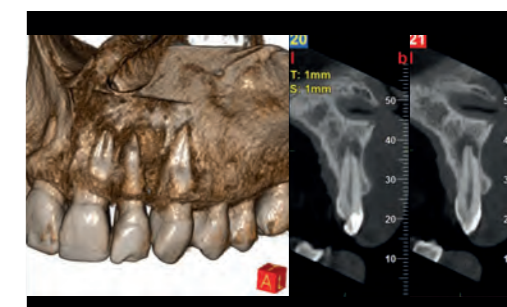



# EXCEPTIONAL DIAGNOSTIC QUALITY.

Modular, upgradeable, technologically advanced: GiANO HR is the perfect solution for every diagnostic need.

GiANO HR has been developed on a modular platform that can be easily updated. The device is available in three configurations that make it the ideal choice for several specialist needs, ranging from dentistry to otorhinolaryngology, maxillofacial surgery and cervical spine examinations.

Conceived by NewToms' experience and advanced technological research, the high sensitivity 16-bit sensor is one of a kind. It has been specifically designed for GiANO HR and improves the image acquisition process.

The powerful high frequency generator with very small focal spot yields excellent scans and reduces patient exposure to a minimum, while ensuring rapid workflow with examinations performed at close intervals without overheating the unit.



## 3D SENSOR AND GENERATOR

- Details up to 68  $\mu\text{m}$  with the wide range 3D sensor's high sensitivity and resolution.
- Powerful pulsed emission generator for rapid low dose scans.

## 3D IMAGING

### SCOUT VIEW IMAGES

The two Scout View images, combined with servo-assisted alignment technology, offer the operator a guided procedure to obtain correct positioning of the patient, while guaranteeing results in every situation.



### 3D RECONSTRUCTION ALGORITHM

Patented algorithms for 3D reconstruction are the technological heart of NewTom research. CBCT technology designed to process 2D images acquired and to generate a volume with isotropic voxel ensures clear and detailed examinations, the ideal choice for dental, maxillofacial and ENT applications.

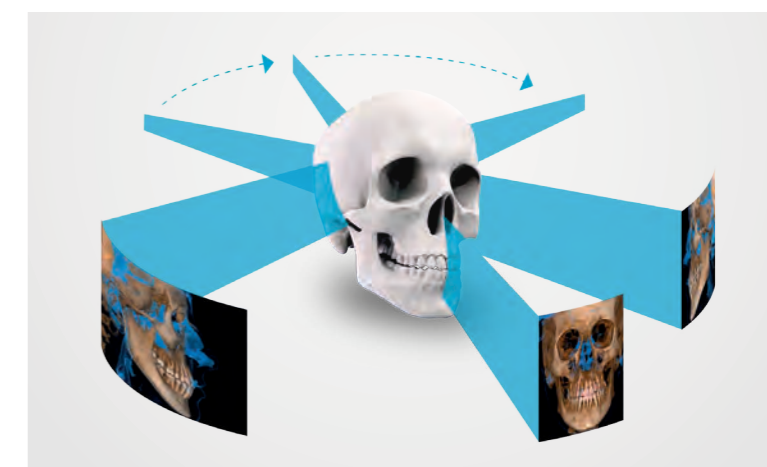

### 360° SCANNING TECHNOLOGY

360° scans and optimised algorithms always ensure optimal outcome. This image acquisition technique yields high quality images and considerably reduces artifacts, with short scan times.





# GUARANTEED EXCELLENT IMAGE QUALITY.

## Advanced characteristics for very high standard diagnosis.

3D volumes rich in details, ideal for any diagnostic need. The innovative image acquisition protocols of NewTom's technological research guide the operator in making the most of GiANO HR's advanced features.

An easy, user-friendly interface to select the most appropriate examination mode. Three pre-set investigation protocols allow to effectively identify the most suitable image acquisition mode.

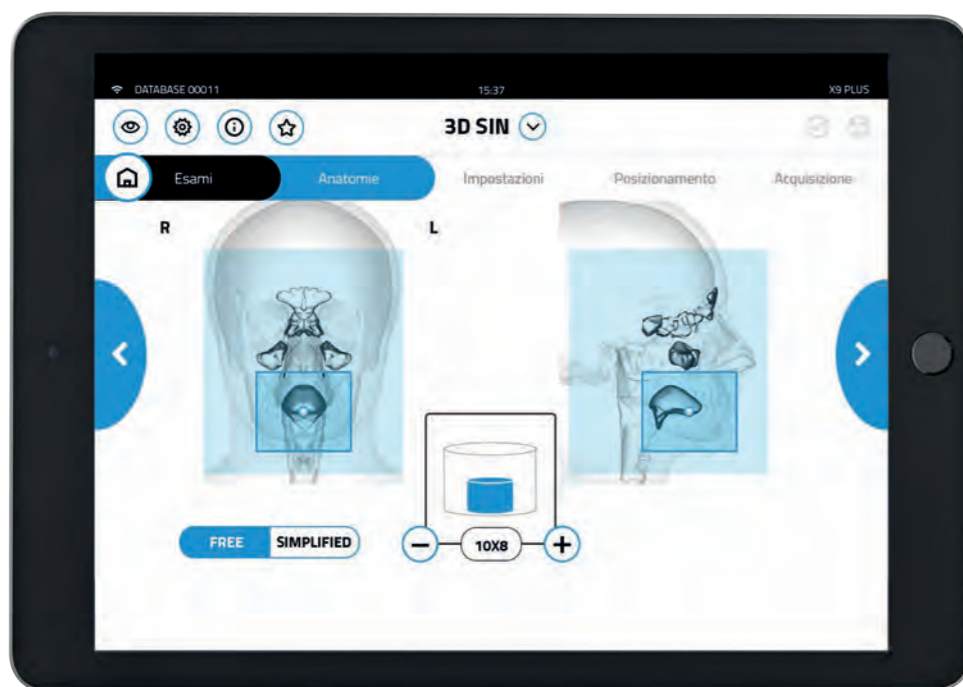

### ECO Scan

Mode indicated for routine examinations, such as post-surgery follow-up and macro-structural analysis.

### REGULAR MODE

High resolution 3D images that are ideal for a primary diagnosis and to plan treatment.

### BEST QUALITY

An exceptional level of detail for the best high resolution images available on the market without compromises.

## aMAR FILTERS

The innovative aMAR (autoadaptive Metal Artifact Reduction) function is a proprietary algorithm developed by NewTom. It considerably reduces the artifacts generated by amalgam, implants or other metal elements that can impair image quality. This facilitates planning and design of specialist treatments that require segmentation of anatomical structures without renouncing the original data acquired.

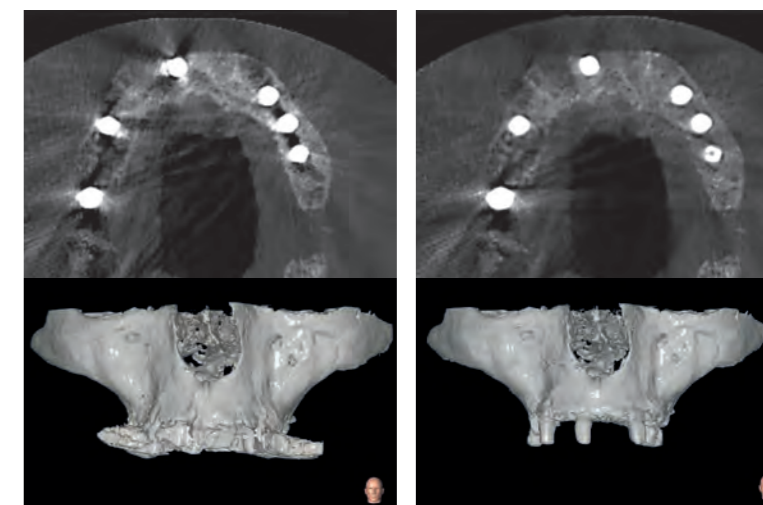

aMAR (autoadaptive Metal Artifact Reduction)

## SHARP 2D PAN AND CEPH (PATENTED)

With cutting edge scanning technology, GiANO HR can generate 2D image samples from a volume already acquired with low dose CBCT scans. These projections offer a more user-friendly assessment of clinical cases for orthodontic planning and post-surgery follow-up.



MULTIVISION (4 IN 1)





## GIANO HR PERFECT.VISION

# THREE CONFIGURATIONS TO MEET EVERY CLINICAL AND DIAGNOSTIC NEED.

NewTom is highly versatile with the choice of most suitable configuration for the diagnostic needs of the clinic or of the radiology practice. 3D Prime configuration is ideal for applications in general dentistry, implantology, endodontics, gnathology and general orthodontics. 3D Advanced configuration extends the potential to the fields of dentistry and otorhinolaryngology (ENT), including examination of upper airways. Professional 3D configuration allows access to a new dimension that includes applications for the entire dental-maxillofacial area and cervical spine.



3D PRIME CONFIGURATION.

# ESSENTIALLY PERFECT.

- General dentistry
- Implantology
- Endodontics
- Gnathology
- General orthodontics

GiANO HR allows the user to always select the programme best suited to the clinical application with a few guided steps. Images of the complete dental arches can be obtained with a single scan or via ultra-high definition sectional acquisition in ECO-Dose mode (ultra-fast scanning). Highly accurate, finely defined 3D volumes provide the detailed information needed for meticulous examination of the site and proper implant assessment. Smaller FOVs, especially suited to paediatric applications, ensure that only anatomical regions of interest are irradiated, thus minimising patient exposure while providing images of the very highest quality. A more powerful X-ray chain ensures high quality telerradiographic projections for general dentistry applications.

**POCKET**

Convenient pocket for the patient's personal items during the scan.

**FOV 10 X 8 cm**

Perfect view of the two dental arches. The 10 cm diameter includes third molars, even in adult patients. Also available with 8 cm diameter for children and patients with a small build.

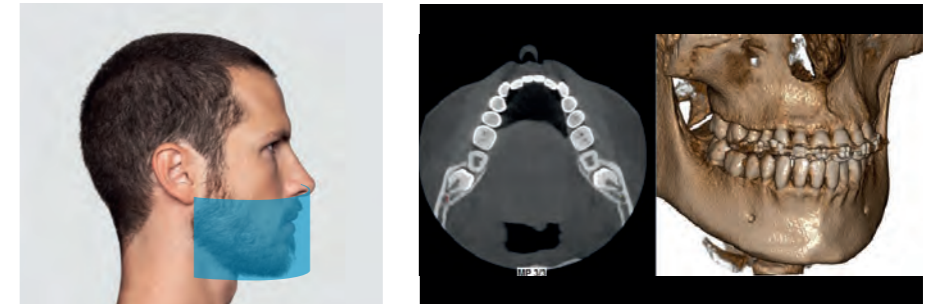
**FOV 10 X 6 cm**

Complete dental arch in the adult. The 6 cm height combined with good positioning always ensures inclusion of all the necessary structures, without cutting out the occlusal zone or the base of the lower jaw.

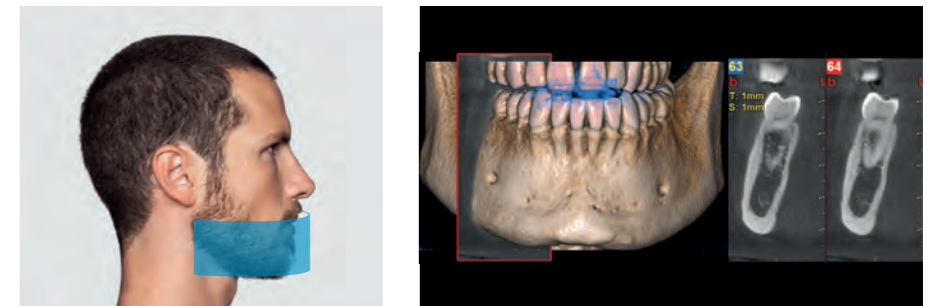
**FOV 8 X 6 cm**

Reduced view to examine a complete single dental arch in children or in patients with a small build.

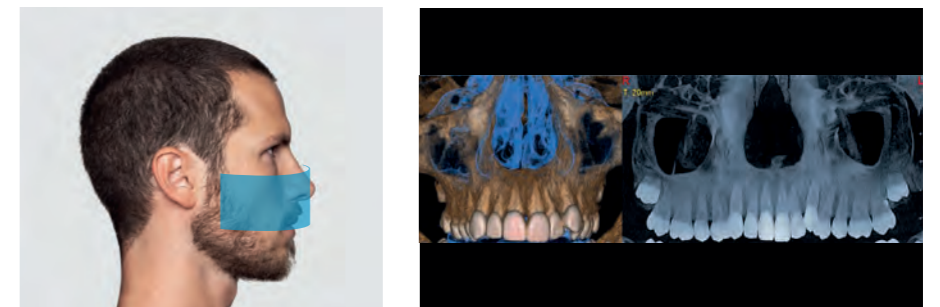
**FOV 6 X 6 cm**

Ideal for sectional view along the dental arch. Partial scan of the individual semi-arches or frontal zone allows to considerably reduce the radiated dose.

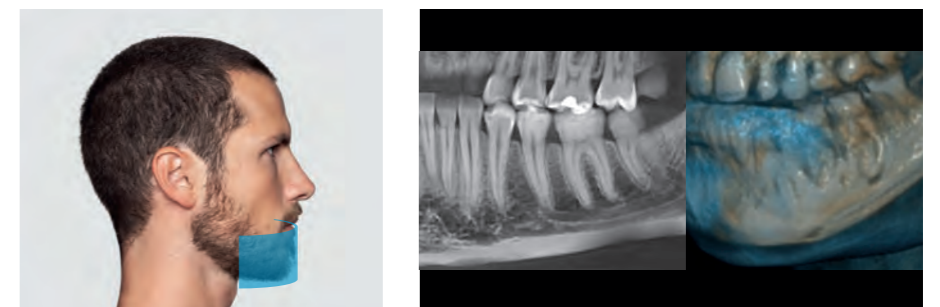



3D ADVANCED CONFIGURATION.

# PERFECT PRACTICALITY.

- General dentistry
- Implantology
- Endodontics
- Gnathology
- General orthodontics
- Otorhinolaryngology

The ideal configuration for full dental applications, from endodontics to orthodontics and otorhinolaryngology (ENT). Using patented technology, GiANO HR Advanced can generate single volumes of up to 13 x 16 cm, providing a complete overview of dentition, maxillary sinuses and airways. An examination performed with GiANO HR highlights characteristics, such as micro-fractures, bone height, root shape and tilt with the utmost precision. Low X-ray doses, combined with the 3D aMAR (autoadaptive Metal Artifact Reduction) function, illustrate anatomical structures clearly even in the presence of metallic objects. An essential requisite for post-surgery scans.

## TOUCH-SCREEN CONSOLE

Maximum efficiency and precise diagnosis with built-in touch screen console and user-friendly workflow.



## FOV 13 X 16 cm

Single volume maxillofacial image obtained automatically: a complete view of the maxillary sinuses and of the entire dental arches. Also ideal for upper airway examinations.

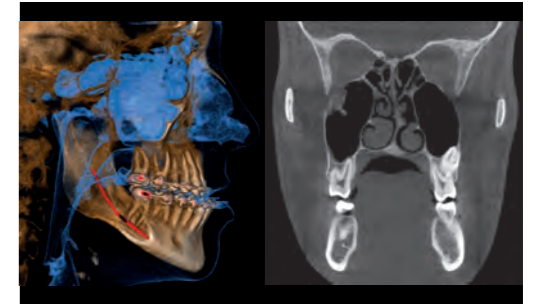

## FOV 10 X 10 cm

For a complete examination of teeth, including the maxillary sinuses, with a single 360° scan and the option of an ultra rapid 6.4 s scan.

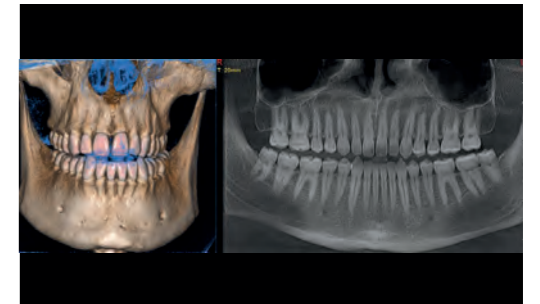

## FOV 13 X 8 cm

For wide range analysis of ascending rami of the mandible or of the zygomatic maxillary region for advanced implant design.

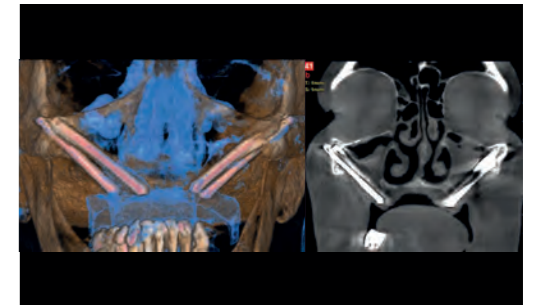

## FOV 7 X 6 cm

High definition image of both the internal ear and the petrous bones for accurate diagnosis or post-surgery control, such as positioning of a cochlear implant.

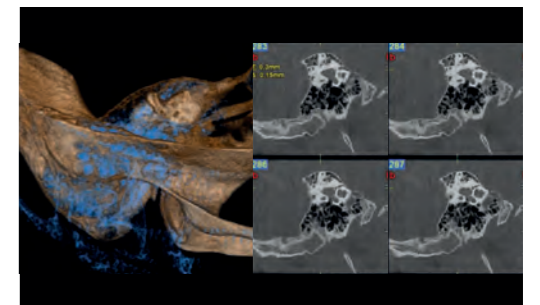



3D PROFESSIONAL CONFIGURATION.

# ABSOLUTELY PERFECT.

- General dentistry
- Implantology
- Endodontics
- Gnathology
- General orthodontics
- Otorhinolaryngology
- Maxillofacial
- Head&Neck

Sharp, detailed 3D images of the entire dental-maxillofacial area with a 16 x 18 cm volume with a resolution among the highest available on the market. Also useful for otorhinolaryngology investigations. Pathologies of the cervical spine can be studied using dedicated trajectories. Examination of both temporomandibular joints in a single scan allows identification of any dysfunction based on the joint space image. Pre-set radiation levels and exclusive SafeBeam™ technology, available with all the configurations, lets users select the best exposure and obtain the optimal dose.



## FOV 16 X 18 cm

Single-scan view of upper airways from the nose to the trachea, both temporomandibular joints, maxillary and nasal sinuses.

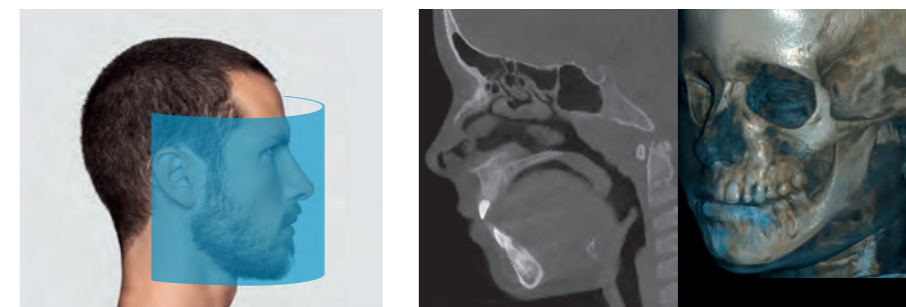

## FOV 15 X 6 cm

Detailed high resolution diagnosis of both temporomandibular joints or of the ear in a single scan.

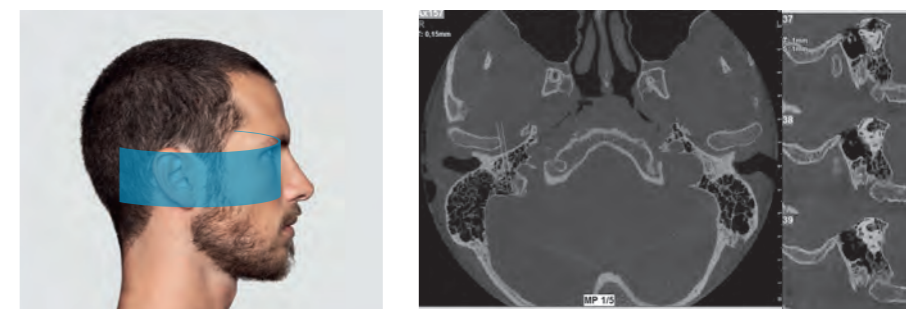

## FOV 16 X 10 cm

Complete panoramic diagnosis of mouth, maxillary and mandibular structures up to the temporomandibular joints.

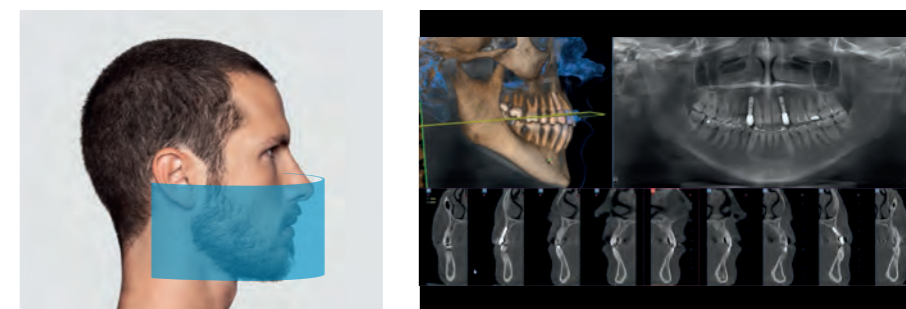

## FOV 4 X 4 cm

Limiting exposure to the region of interest and using 3D XF (eXtra Functions) allows to considerably reduce the radiated dose and to obtain images with exceptional resolution of 68 μm. For endodontic applications and optimal view of details, such as any secondary canals.





# COMFORT, SAFETY AND COMMON DIAGNOSIS.

## Accurate diagnosis and the utmost care for patient health.

GiANO HR is designed for excellent comfort and safety for the patient in all situations as a result of outstanding ergonomics and very low emission times. Auto-adaptive positioning with three laser guides and 7-point head support unit make the process easy and always ensure aligned images.

### LOW DOSE

During the examination, the pulsed generator allows minimum patient exposure to radiations (33% - 25% of scan time).

### ECO SCAN 3D

Allows to obtain volumetric images with a rapid scan (minimum 3.6 seconds) and with a considerably reduced patient dose (minimum exposure only 0.9 seconds).

### SAFEBEAM™ (patented)

Automatically adapts the radiated dose to the patient's build, reducing the possibility of an unnecessarily high dose.

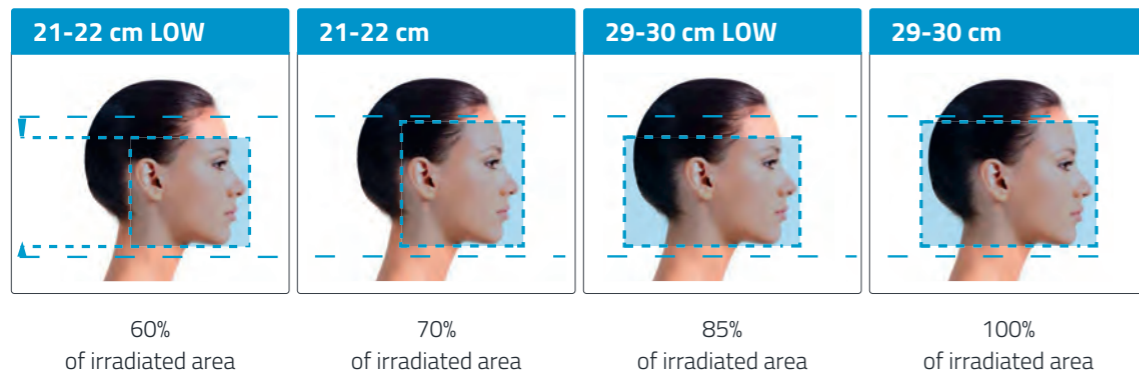

### ADAPTIVE FOV

Modular fields of view allow to precisely select the area to be exposed, both for 2D and 3D examinations, thus limiting radiation only to the anatomical regions to be diagnosed. The secondary collimator for teleradiographic examinations is positioned inside the gantry, thus leaving more moving space for both operator and patient.

## EASY COMMUNICATION WITH PATIENT

Software sharing options, preview on the control panel and application for tablets are the ideal tools to communicate with the patient and establish relations based on trust.



## INNOVATIVE HEAD SUPPORT UNIT FOR MAXIMUM STABILITY

The exclusive 7-point head support unit and laser guides projected on the face ensure excellent patient stability and precise patient positioning. The precise laser guide lights allow positioning check and early identification of the height of the 3D FOV that best suits specific needs. The motor-driven alignment system and Scout views make it easy to prepare the examination for functional and effective workflow.



## CEPH POSITIONING

The innovative geometry of GiANO HR's CEPH system expands space available for the patient, while maintaining minimum work space. Available with right to left configuration. The patient always faces the operator, while specific guards for paediatric applications allow to include the skull cap and to reduce under-chin tissue exposure. The precise laser guidance allows perfect patient alignment in NHP.





# NNT. INTEGRATED SOFTWARE PLATFORM.

The ultimate platform to acquire, process and share 2D/3D diagnostic images.

NNT is NewTom's software that provides several dedicated application modes specifically intended for implantology, endodontics, periodontics, maxillofacial surgery and radiology. It is a powerful technologically cutting edge device designed to acquire and process images in a few simple steps to obtain the information required for specific detailed patient diagnosis.

Advanced software that provides the specialist physician with dedicated tools to measure the anatomic district (distances and angles), trace the inferior alveolar nerve, and measure upper airway volume.

## MEDICAL INTERFACE

NNT is DICOM 3.0 compatible and can interface with third party systems and software to store and exchange medical data.

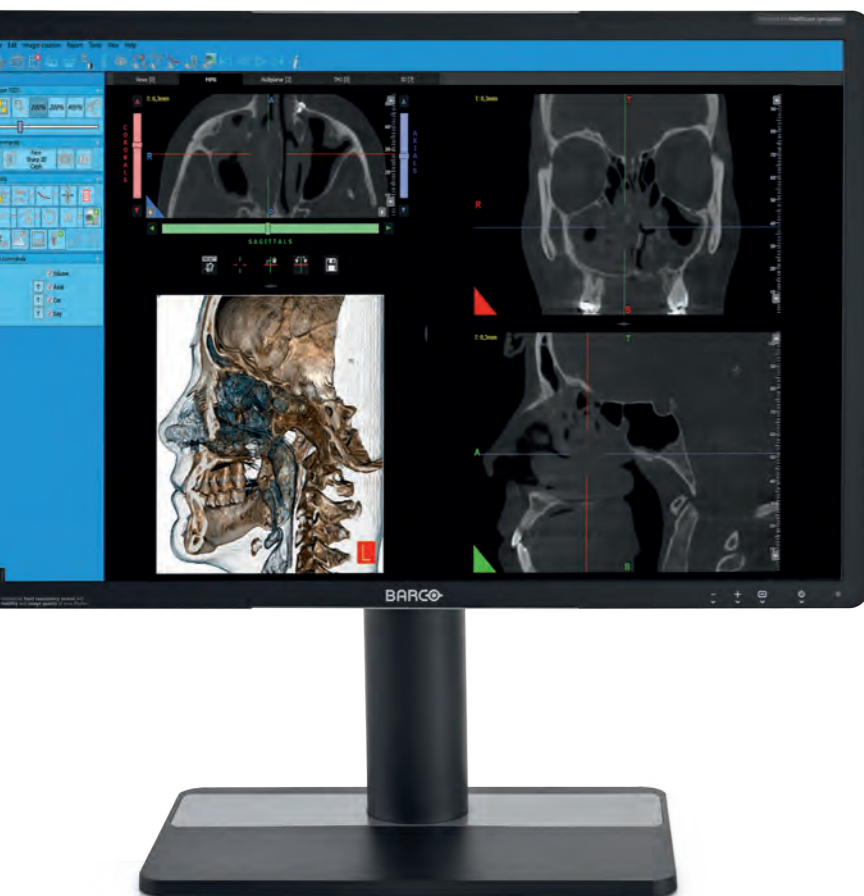

## DENTISTRY: CROSS SECTIONS IN PANORAMIC IMAGES

Complete view of the dental arches in cross sections to check shape, size and status of maxillary and mandibular bones and teeth.

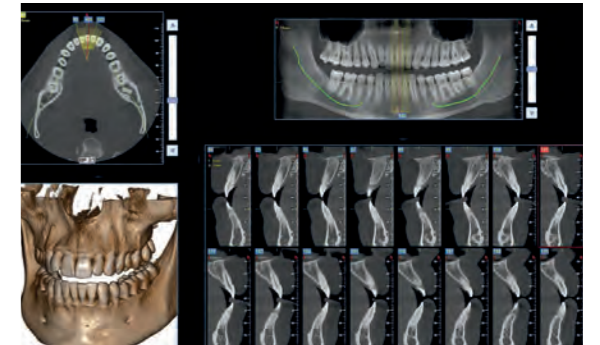

## OTORHINOLARYNGOLOGY: FREE MULTIPLANAR SECTIONS

Dynamic high resolution examination of the internal ear along non-orthogonal planes is essential to diagnose any diseases of the ossicular chain, stapes' base, semicircular canals, cochlea and adjacent structures.

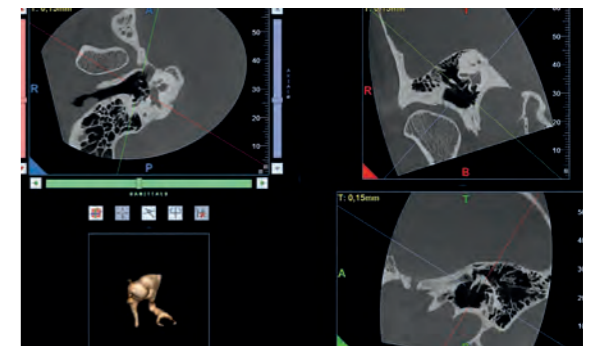

## GNATHOLOGY: DUAL TMJ VISION

Simultaneous view of both temporomandibular joints for symmetrical analysis and detection of problems or dysfunctions deriving from joint diseases.

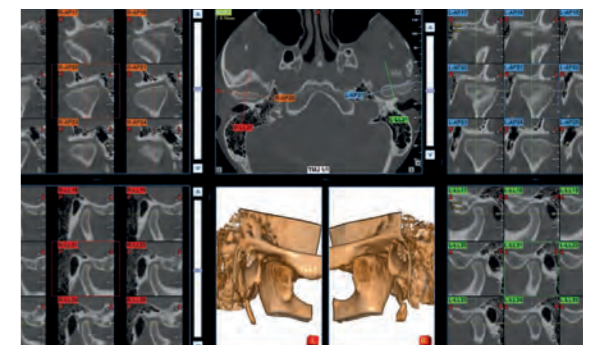

## RADIOLOGY: MULTI-SLICE EXAMINATION

Creation of multiple image samples in Med-Like style with personalised orientation for the various assessments of anatomical districts, whose images have been acquired.

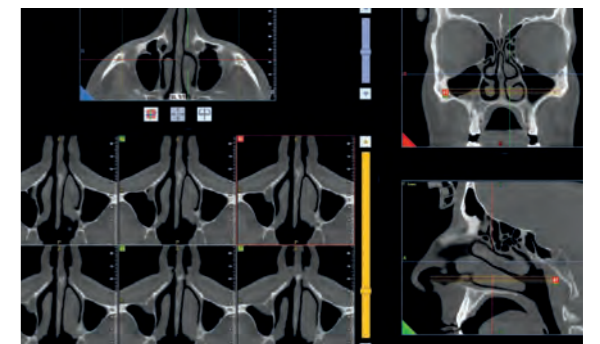



## SPECIALIST NEWTOM TOOLS.

Dedicated tools to underpin diagnoses and treatment plan.

NNT includes all the applications needed to perform the examination, process 2D/3D images and share them in a simple and effective way with specialized software that allows virtual planning of patient treatment, in order to optimize both work quality and timing through specially designed digital platforms. A variety of work modes and functions respond to the specific needs of implantology, endodontics, periodontics, orthodontics, maxillofacial surgery and radiology, allowing treatment to be planned after a full, accurate assessment of each case.

### SMART SERVICES FOR 2D AND 3D ORTHODONTICS

Through the CephX cloud server, NNT has access to online artificial intelligence services. This futuristic tool allows automatic cephalometric tracing, to be managed with instant reporting. It is also possible to carry out volume segment by body areas, making each case study even more straightforward, practical and obvious. Finally, airway examination can also be performed with maximised efficiency and accuracy.

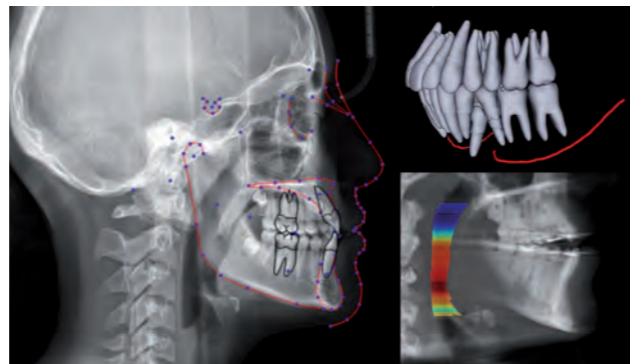

### INTEGRATED SOLUTION FOR THE SMILE PROJECT

As part of the aesthetic smile rehabilitation project, the Smile LynX software integrated in NNT simulates the treatment outcome on a photograph of the patient, facilitating communication with both the patient and the dental laboratory, which can then use this information to create a more effective CAD project, directly integrated with 3D Lynx.

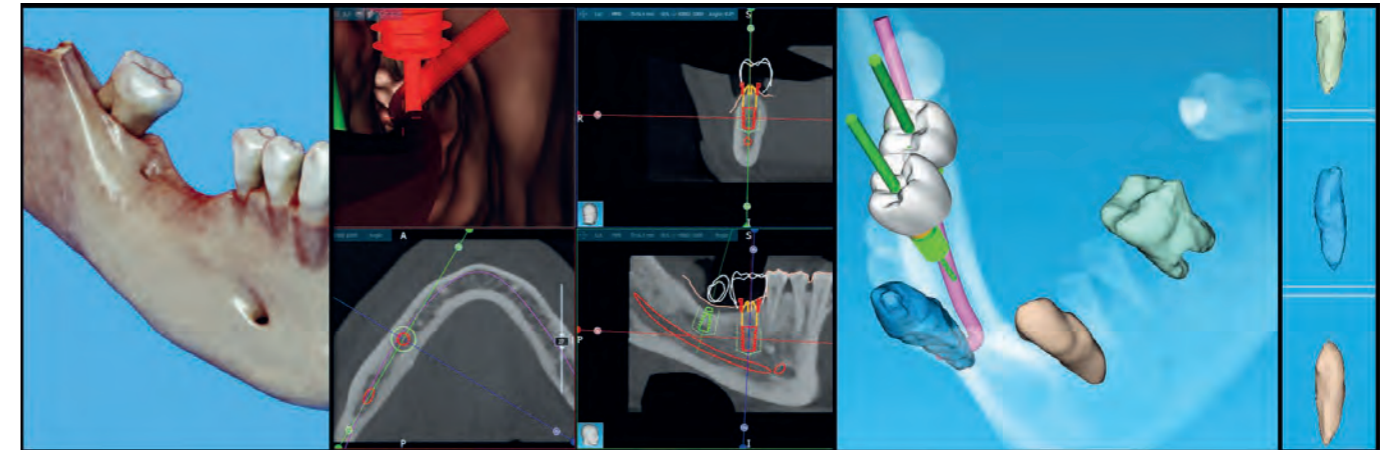

### PROSTHETICALLY GUIDED IMPLANT DESIGNING

The module allows implant surgery to be planned with extreme precision. The implant can be positioned by assessing both clinical aspects (bone quality, canal position, etc.) and prosthetic details by combining 3D reconstruction of radiological data with the optical scan of an anatomical model and the related prosthetic project (importable in STL format). The possibility of creating a surgical template for use during the clinical procedure allows implants to be positioned with extreme precision and predictability. Virtual endoscopy navigation ensures an even more intuitive dynamic analysis of the clinical data.

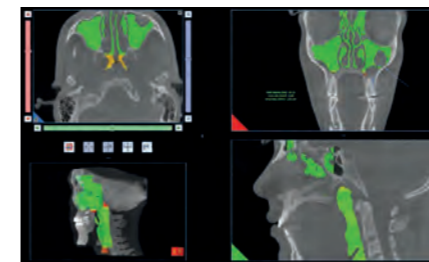

### AIRWAY VOLUME ANALYSIS

Estimating the actual upper airway space is essential to diagnose respiratory diseases and sleep apnea (OSA).

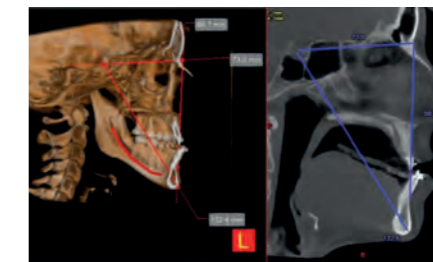

### 2D AND 3D EVALUATION

The possibility to evaluate distances on 2D sections or with 3D rendering to verify any joint problems.

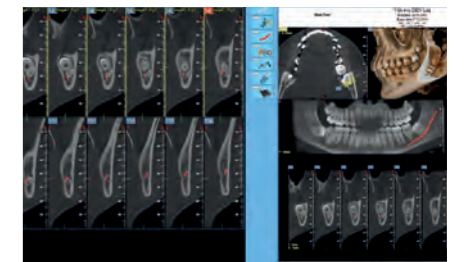

### ADVANCED REPORTS

Advanced writing of medical reports to share on PACS, also available in automatic compiling mode.



## AN INTERCONNECTED SYSTEM.

An extensive communication environment, from multidisciplinary treatments to technical assistance.

GiANO HR benefits from the sharing tools provided by NewTom to improve operations within the dental practice. In particular, the sharing of images and data via cloud optimises the implant rehabilitation process, by ensuring communication between the dentist, implantologist and dental technician. In addition, the Easy Check and Di.V.A. services simplify the monitoring and maintenance of the machines. A proper ecosystem, in which each component interacts with the others to maximise performance.

### ALWAYS EFFICIENT

GiANO HR, like all the other NewTom extra-oral imaging instruments, can be monitored automatically through the Di.V.A. digital virtual assistant, which provides data and usage statistics to help plan workloads and maintenance. Moreover, GiANO HR has access to a remote technical assistance service through the Easy Check software, which provides information on any critical issues and streamlines their resolution in real time.



### NNT VIEWER (DEVICE&APP)

Intuitive and efficient, NNT has all the tools to manage and share diagnostic images, facilitating communication with the patient and with the other dental professionals involved. The viewer supplied with the system can be used to browse through the iPad-based 2D image gallery, and all scans can be transferred in DICOM format. The NNT Viewer can be given free of charge to colleagues and patients to allow them to also view images. In addition, NNT is compatible with the MAC platform through Parallels Desktop.



### WORKFLOW ON CLOUD-BASED MULTI-PLATFORM

NNT provides the implantologist with a cloud-based platform where to store libraries of implants and abutments. The implantologist can thus plan surgical procedures and share data with the dentist and dental technician, by also being able to access a secure chat system. The platform ensures a certified, optimised workflow designed for specialist clinical use, aimed at creating surgical templates by using 3DIEMME services or producing them in-house via the RealGUIDE DESIGN software version and 3D printer. Among the many features available, there are importing and overlay of STL files, PLY of digital impressions and/or prosthetic designs obtained via an optical scanner; simplified segmentation of the volumetric data of anatomical parts, exportable to STL; and project exporting to open CAD/CAM software for provisional implant management.





# COMPLETE CONNECTIVITY.

Excellent connectivity and integration with the modern systems adopted by NewTom. Workflow and clinical and diagnostic activities become much easier and highly performing.



## VIRTUAL CONSOLE

Settings required for acquisition can be easily controlled from a remote virtual control panel on the PC, laptop, Windows tablet or iPad.

## REMOTE ASSISTANCE

By appropriately configuring the device to use the surgery's Internet connection, technical support can be provided remotely, and device status can be monitored.

## 3D/2D VIEWER

Examinations can be shared with colleagues and patients by providing the Viewer directly on CD, DVD or a USB storage device.

## 1:1 PRINT

Complete and flexible reporting system for storing and sharing colour reports on photographic paper or grey scale reports on X-ray-equivalent transparencies.

## OTHER ACQUISITION DEVICES

Compatibility with TWAIN and DICOM 3.0 standards guarantees NNT software management of images from other 2D/3D image acquisition devices, such as video cameras, sensors, PSP and CBCT scanners.

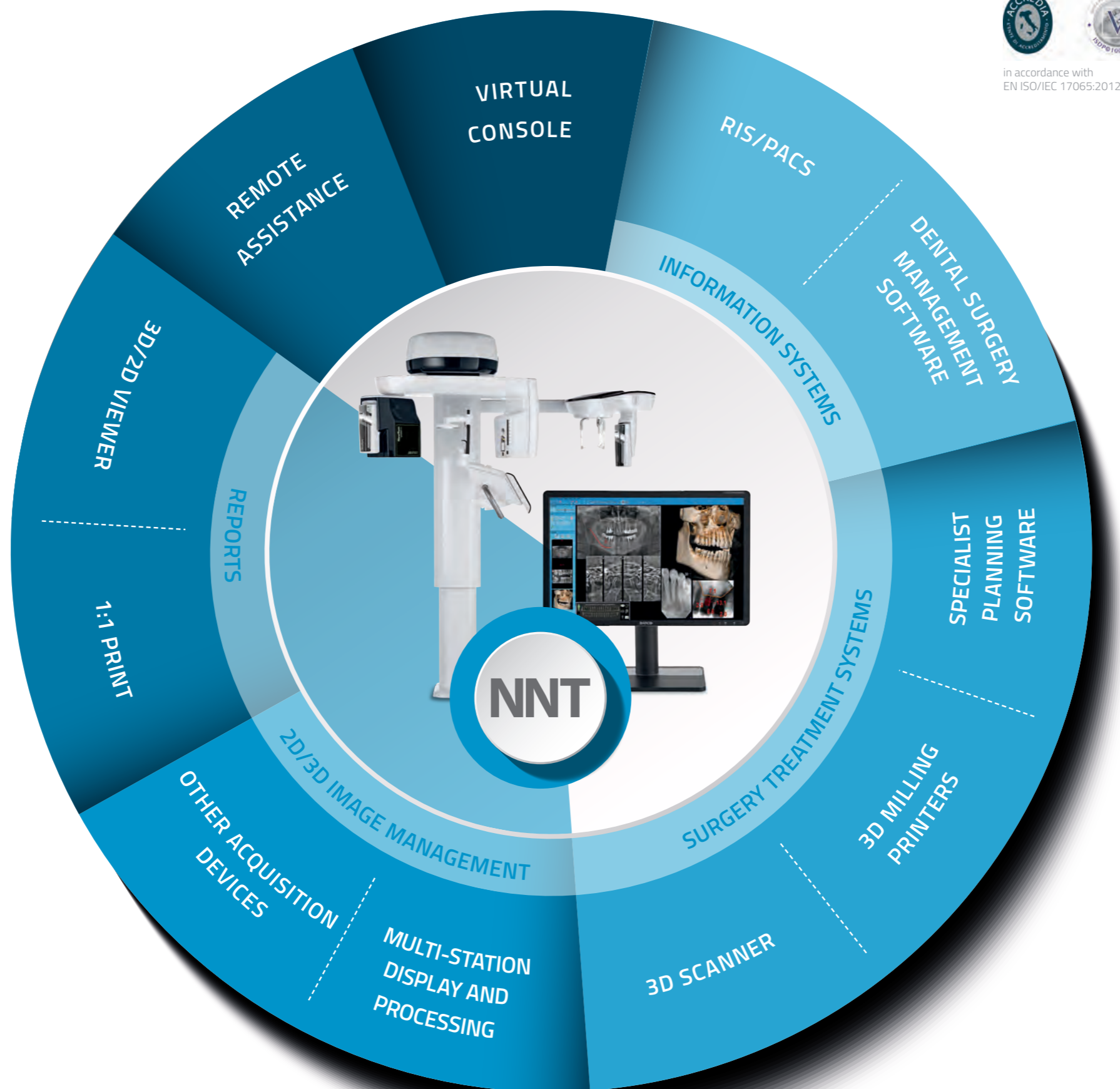

in accordance with  
EN ISO/IEC 17065:2012

## NNT: CERTIFIED SOFTWARE

NNT has been granted the ISDP® 10003 international scheme for data protection certification, to assess compliance with the European Regulation 2016/679 concerning the protection of individuals with regard to the processing of personal data.

## RIS/PACS

IHE compliant system that allows communication with RIS/PACS systems and DICOM printers. Complete services available: Print, Worklist, Storage Commitment, MPPS and Query/Retrieve.

## DENTAL SURGERY MANAGEMENT SOFTWARE

An open system designed for fast, efficient interfacing with the main dental surgery management software solutions via various standard VDDS, TWAIN and/or proprietary NNTBridge modes.

## SPECIALIST PLANNING SOFTWARE

Exports in DICOM 3.0 format to specialist planning software to process orthodontic treatments, prostheses, implants, orthognathic and maxillofacial surgery.

## 3D MILLING PRINTERS

Software modules are available to segment the reconstructed volume and export to STL format the surfaces required to create 3D models that can underpin planning and treatment.

## 3D SCANNER

Prosthetically guided planning by integrating (via the dedicated software module) data in STL format from optical, intraoral or laboratory scanners, with volumetric data.

## MULTI-STATION DISPLAY AND PROCESSING

Image storage on a shared database in a local network that can be accessed from any workstation and iPad (only 2D). Management of multiple archives and access to password-protected data.

# TECHNICAL SPECIFICATIONS.

2D version	2D images	
	PAN Standard	PAN DC <sup>III</sup>
Main Examinations	<ul style="list-style-type: none"> <li>Panoramic Multilayer</li> <li>Quadrants,</li> <li>Bitewing</li> <li>Maxillary Sinuses (AP and LL)</li> <li>TMJ PA-LL</li> </ul>	Adds, with respect to the PAN version, teleradiography <ul style="list-style-type: none"> <li>Latero-Lateral</li> <li>Antero-Posterior</li> <li>Carpus</li> </ul>
Child examination	Yes	Yes
Maximum resolution	6.3 - 7.5 lp/mm (Pixel 70-80 µm)	5.6 lp/mm (Pixel 90 µm)
Contrast level	23% (at 3 lp/mm)   43% (at 3 lp/mm)	32% (at 2.5 lp/mm)   82% (at 2.5 lp/mm)
Maximum size (cm)	26 (length); 15 (height)	29-30 (length); 22-23 (height)
Reduced size (cm)	Length x Height <ul style="list-style-type: none"> <li>22 x 13 (Child PAN);</li> <li>17 x 12 (Complete DENT)</li> <li>13 x 9 (BITEWING Right or Left)</li> </ul>	Length x Height <ul style="list-style-type: none"> <li>21-22 x 22-23 (Adult)</li> <li>29-30 x 20 (Child)</li> <li>21-22 x 20 (Child)</li> </ul>
Maximum image data size	8 MB	14 MB
Magnification factor	PAN 1.25 (constant)	1.13
ECO Scan scan time	Adult: 6 s   Child: 5.7 s	Low Adult: 4.5 s   Child: 3.2 - s 3.3 s
Standard scan time	Adult: 12.3 s   Child: 11.2 s	Complete Adult: 7.5 - 9 s
Advanced filters	ApT (Autoadaptive picture Treatments)	
FULL-TOUCH 10" control panel on-board the machine*	Optional	

3D version	3D images		
	PRIME	ADVANCED	PROFESSIONAL
Main Examinations	Compared to the 2D version, it features 3D analysis of: <ul style="list-style-type: none"> <li>2 dental arches in a single scan for adults and children with reduced collimation;</li> <li>maxillary region with maxillary sinuses;</li> <li>studies localised to DENTAL region of interest or to single TMJ.</li> </ul>	Compared to the PRIME version, it features 3D analysis of: <ul style="list-style-type: none"> <li>upper airways, either complete or partial, with variable collimation for frontal sinuses, nose and throat;</li> <li>zygomatic implants;</li> <li>one internal ear;</li> <li>localised study of few teeth with maximum collimation or maximum effective resolution for endodontic examinations or to evaluate micro-fractures.</li> </ul>	Compared to the ADVANCED version, it features 3D analysis of: <ul style="list-style-type: none"> <li>the whole Dental-Maxillofacial region;</li> <li>both ears;</li> <li>panoramic view with two temporomandibular joints;</li> <li>cervical column.</li> </ul>
Child examination	Yes	Yes	Yes
Resolution	Voxel 75 - 300 µm	Voxel 68 - 300 µm	Voxel 68 - 300 µm
Maximum field of view (cm)	10 (diameter); 8 (height)	13 (diameter); 16 (height)	16 (diameter); 18 (height)
Available fields of view FOV Diameter x Height (cm)	<ul style="list-style-type: none"> <li>10 x 8; 10 x 6; 8 x 8; 8 x 6; 6 x 6</li> </ul>	<ul style="list-style-type: none"> <li>13 x 16; 13 x 14; 13 x 10; 13 x 8; 10 x 10;</li> <li>10 x 8; 10 x 6; 8 x 8; 8 x 6; 6 x 6</li> </ul>	<ul style="list-style-type: none"> <li>16 x 18; 16 x 10; 15 x 6;</li> <li>13 x 16; 13 x 14; 13 x 10;</li> <li>13 x 8; 10 x 10;</li> <li>10 x 8; 10 x 6; 8 x 8; 8 x 6; 6 x 6</li> </ul>
3D eXtra Functions FOV Diameter x Height (cm)	NO	9 x 9; 7 x 6; 4 x 4	9 x 16; 9 x 9; 7 x 6; 4 x 4
Maximum image data size	< 495 MB	215 MB - 820 MB	360 MB - 820 MB
ECO Scan scan time (exposure time)	6.4 s (1.6 s)	3.6 s - 26 s (0.9 s - 4.8 s)	3.6 s - 26 s (0.9 s - 4.8 s)
Regular Mode scan time (exposure time)	14.4 s (3.6 s)	14.4 s - 28.8 s (3.6 s - 7.2 s)	14.4 s - 28.8 s (3.6 s - 7.2 s)
Best Quality scan time (exposure time)	26.4 s (8 s)	16.8 s - 33.6 s (5.2 s - 10.4 s)	16.8 s - 33.6 s (5.2 s - 10.4 s)
Mean image viewing time	Minimum: 15 s	Minimum: 1 s	Minimum: 1 s
Advanced filters	aMAR (auto-adaptive Metal Artifact Reduction)		
FULL-TOUCH 10" on-board console*	Supplied, except for the PRIME version (optional)		

\*always included for versions distributed in the USA and CANADA

Specifications subject to change without prior notice.



X-ray generator	
Generator type	Constant high frequency potential:100-180 kHz
Anode voltage	<b>2D:</b> 60 kV - 85 kV   <b>3D:</b> 90 kV (Pulsed mode)
Anode current	2 mA - 16 mA
Focal spot	0.5 mm (IEC 60336) - Fixed anode
Exposure Control	Auto-Adaptative with intensity modulation during rotation - SafeBeam™ Technology
Maximum continuous anode input power	42 W (1:20 at 85 kV/10 mA)
Inherent filtration	<b>2D:</b> >2.5 mm Al eq. (at 85kV)   <b>3D:</b> 6.5 mm Al eq. (at 90 kV)

Image Acquisition	
Detector type	<b>2D:</b> traditional with scintillator (CsI) or Direct Conversion (DC <sup>III</sup> technology) <b>3D:</b> high resolution Amorphous Silicon (CsI)
Image Dynamic Range	<b>2D Standard:</b> 14 bit (16384 grey levels) <b>2D DC:</b> 16 bit (65536 grey levels)   <b>3D:</b> 16 bit (65536 grey levels)

Ergonomics	
Patient alignment	Supported by 4 laser guide lights marking reference planes and height of the FOV
Patient positioning	7 head contact points
Adjustments	On-board keypad and/or virtual console for iPad (2-speed height drive)
Examination selection	Virtual console on PC, Windows tablet and/or iPad and from Full-Touch 10" on-board console
Notes	Easy access for patients in wheelchairs

Connectivity	
Connections	LAN / Ethernet
Software	NNT (ISDP®10003:2018 compliant in accordance with EN ISO/IEC 17065:2012 certificate number 2019003109-1) with Viewer software, free
Supported protocols	DICOM 3.0, TWAIN, VDDS
DICOM nodes	IHE compliant (Print; Storage Commitment; WorkList; MPPS; Query/Retrieve)
App iPad	Virtual control panel for the device and for the NNT 2D viewer

Installation	
Minimum available work space requirement	<b>2D and 3D PAN:</b> 1400 x 1200 mm - <b>2D and 3D CEPH:</b> 1400 x 1790 mm
Package dimensions (L) x (D) x (H) in mm	Machine Base: 1515 x 1750 x 670 mm - CEPH application: 1030 x 530 x 360 mm
Weight	<b>2D PAN:</b> 155 Kg - 342 lbs   <b>2D CEPH:</b> 175 Kg - 386 lbs <b>3D PAN:</b> 155 Kg - 342 lbs   <b>3D CEPH:</b> 175 Kg - 386 lbs
Accessories	Wall bracket even at 45° or floor support, free standing base available User-friendly for patients on wheelchair

Power supply	
Voltage   Frequency	115 - 240 Vac, +/- 10%   50/60 Hz +/- 2 Hz
Maximum absorbed surge current	20 A at 115 V; 12 A at 240 V
Absorbed power in stand-by mode	20 Watt
Notes	Automatic adaptation for voltage and frequency

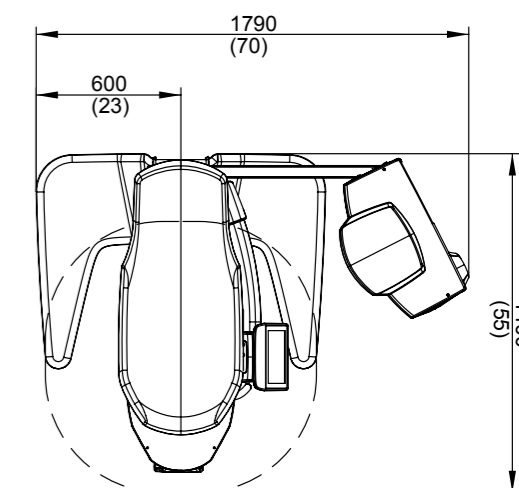
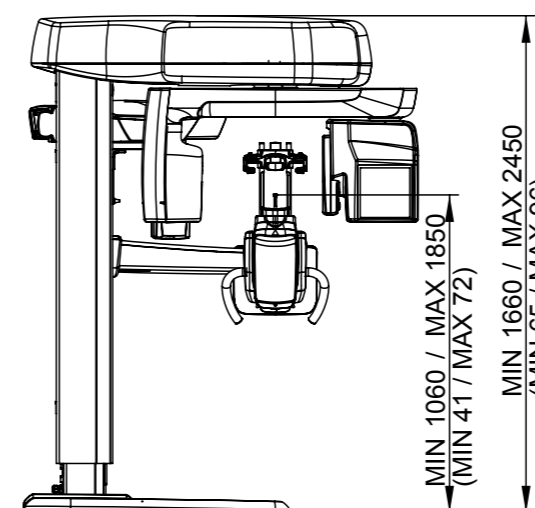

Dimensions in millimeters (dimensions in inches)